

Introduce of ODIN(Open Data Index Name) & PTTP(Peer Trusted Transfer Protocol)

Welcome to PPK pub!

ppkpub@gmail.com
<http://ppkpub.org>
ppk:0



About PPkPub

PPkPub is a public group with a few P2P technology geeks.

Through years practice to digital encryption currency field, PPkPub found the special value of blockchain technology, which would be the next generation network infrastructure. Now we are focus on open source projects named ODIN(Open Data Index Name) and PTTP(Peer Trusted Transfer Protocol) that push together the blockchain and network communication technologies such as the InterPlanetary File System(IPFS),Named Data Network(NDN), Content-Centric Networking(CCN),etc.



**Now Internet based IP is transfer channel.
No change in future ?**

Bitcoin/Blockchain: Revolution

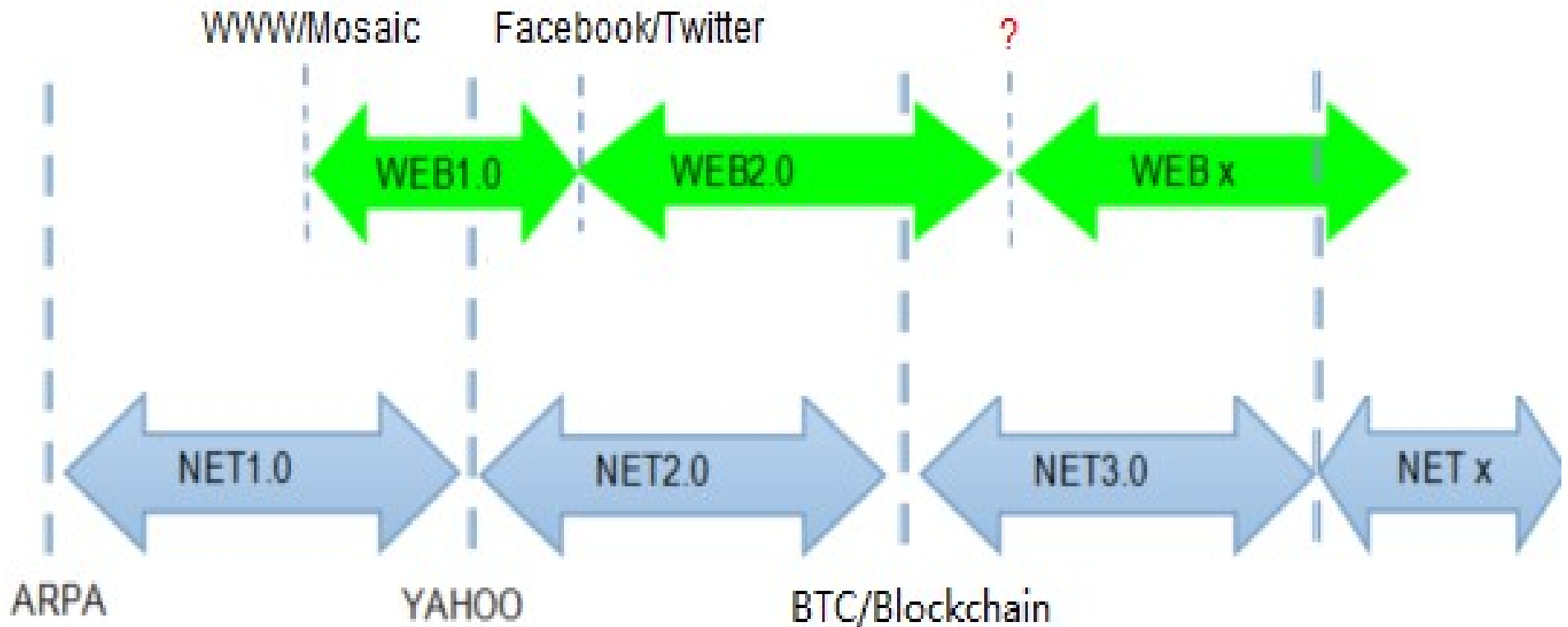

In history, Bitcoin/Blockchain is the first case that achieves the perfect consistency in logic with decentralized organization. It would push forward the Internet to "NET3.0" :

Decentralized, Out of control , Self-organization.

1+1>2: Multi-layer Architecture

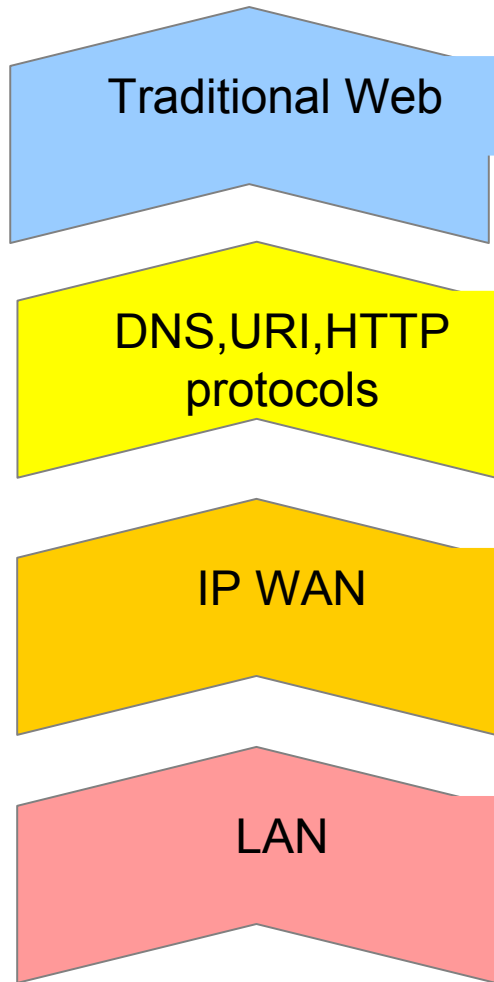

Traditional Internet

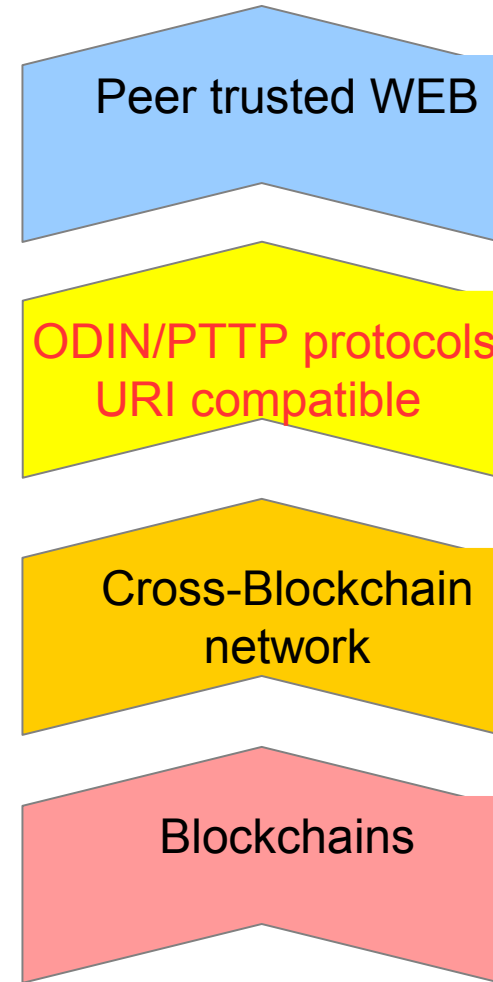

Peer Trusted Internet of Value



Our Roadmap: Start from Naming

More applications using ODIN and PTTP protocols.
Push together to build a new peer trusted WEB.

Prototypes of using ODIN and PTTP protocols

Publish Peer Trusted Transport Protocol (PTTP)

More samples of carrying ext ODIN on more blockchains
like Ethereum, Bytom, Nebulas, Fabric and more.

Implemented root ODIN on the Bitcoin blockchain

Published basic define of ODIN naming system



ODIN: New DNS based on multi-blockchains

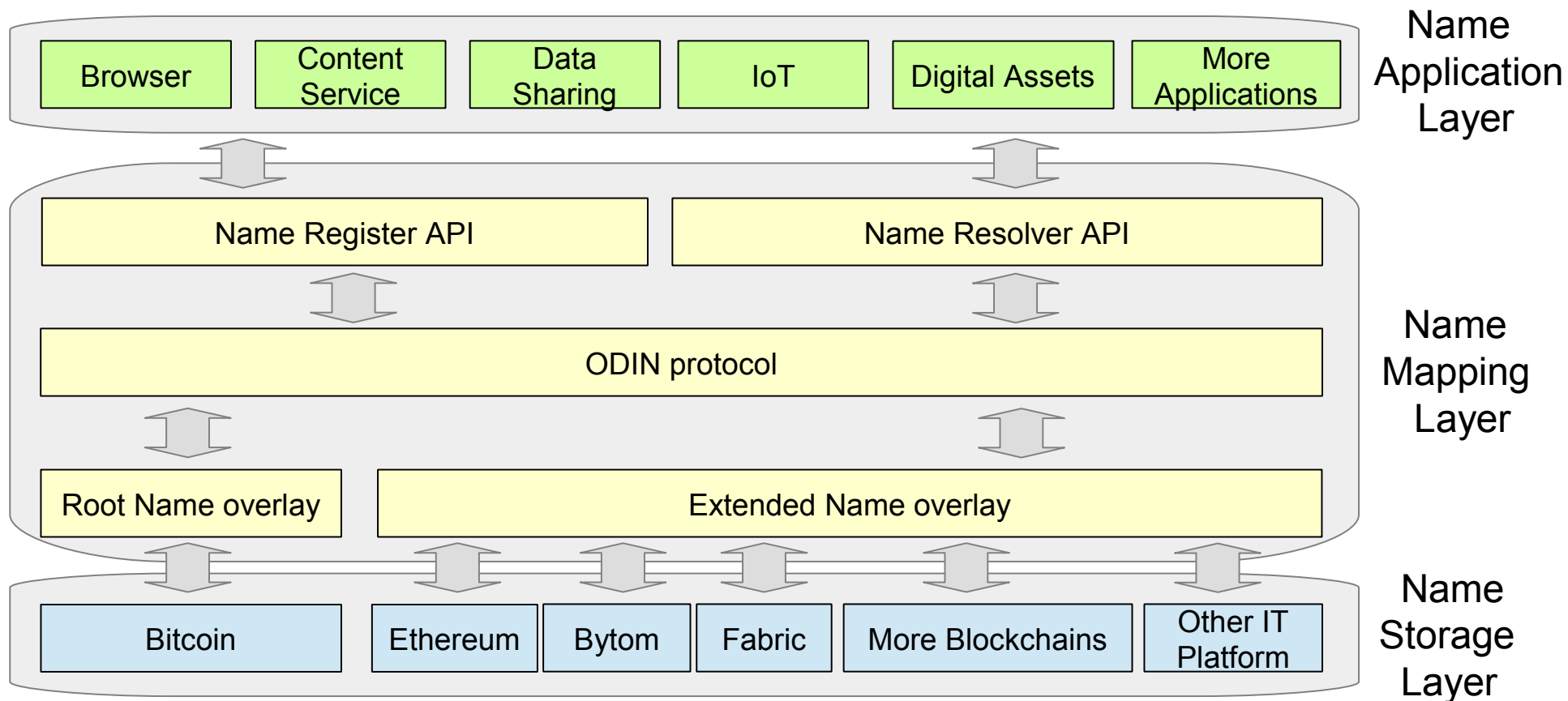

Be based on Blockchain, ODIN(Open Data Index Name) provides the **UNIQUE ,AUTONOMOUS** and **DECENTRALIZED** DNS solution for the future Internet.It is an open system for autonomous identification and data content index in the peer-to-peer network environment .

ODIN schemes

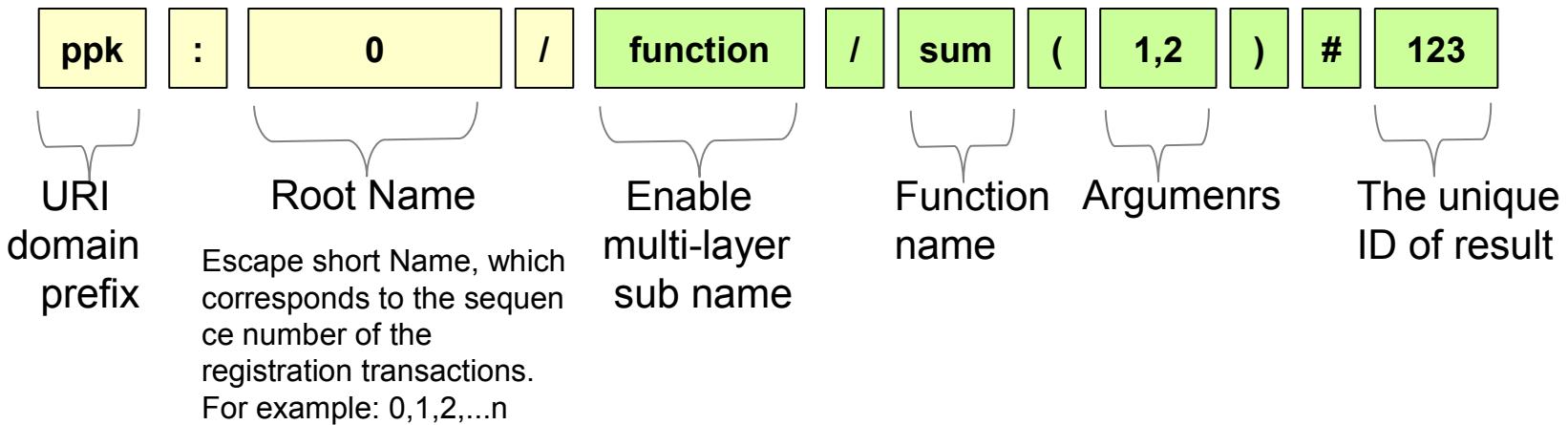
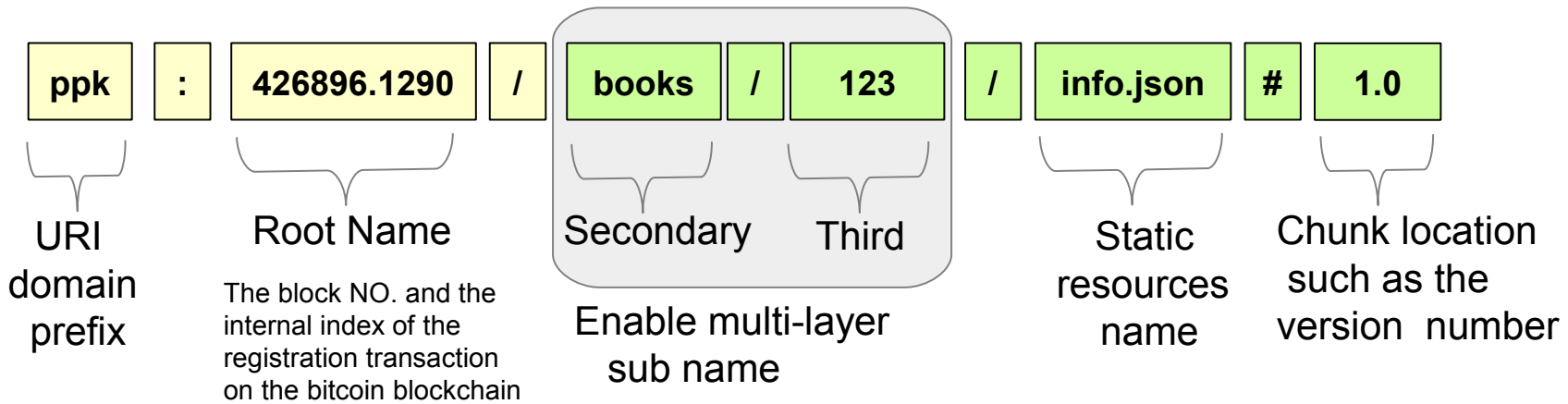

ODIN follow the URI (Uniform Resource Identifier) specification.



ADVANTAGE of ODIN vs DNS

Autonomy

Uniqueness

Security

Persistence

ODIN vs Other name systems based blockchain

	ODIN	Namecoin	Onename
Root blockchain	Bitcoin	Namecoin	Namecoin → Blockstack based Bitcoin
Ext blockchains	Support sub-name based more blockchains such as public 、 federated or private blockchains.	--	--
Name format	Use the record index position on the blockchain as unique name	Squatting ASCII string	Squatting ASCII string

How ODIN works on Bitcoin blockchain?

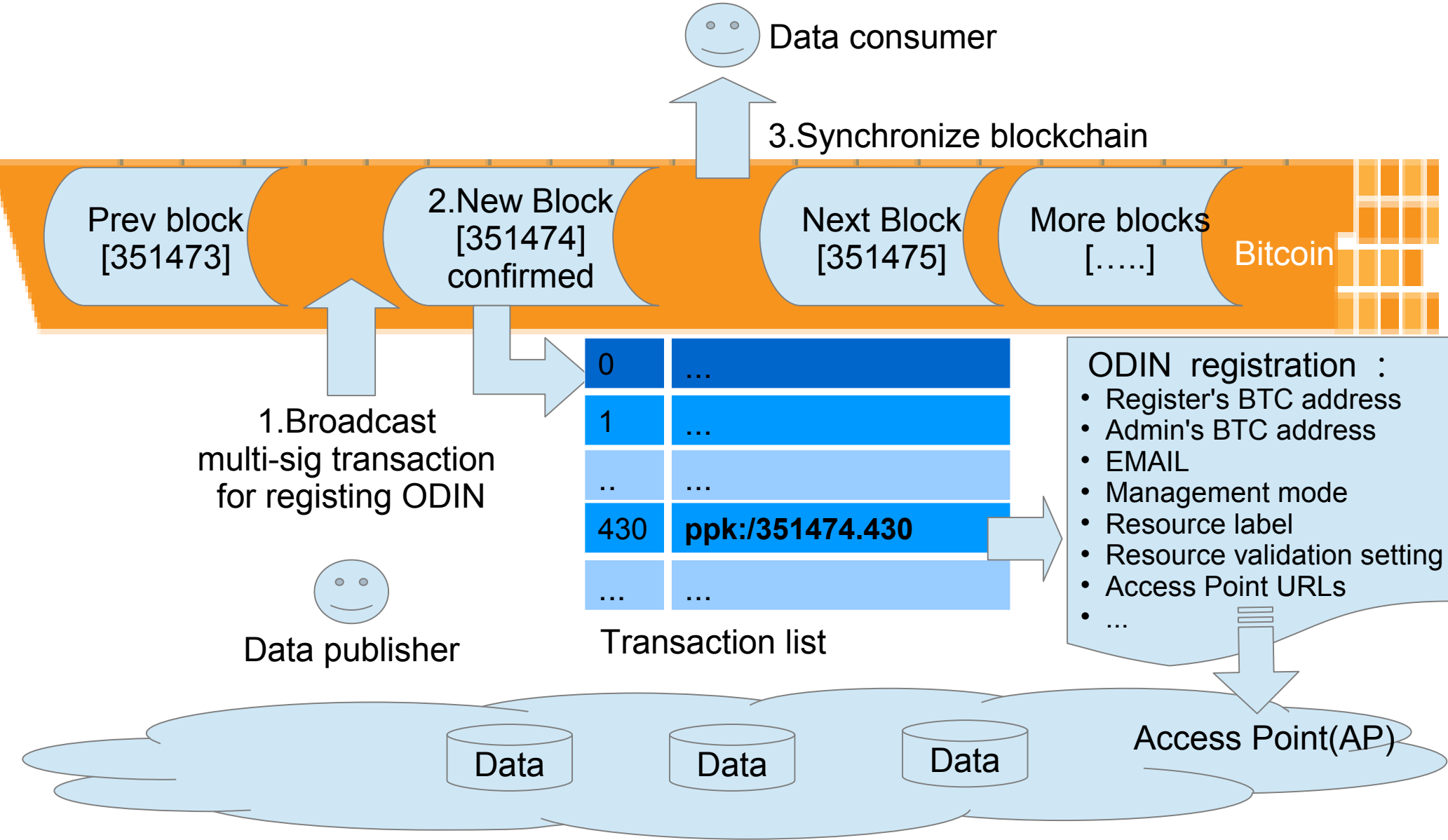

ODIN is fully open and autonomous

PTTP: New HTTP that is peer trusted

PTTP(Peer Trusted Transfer Protocol) integrates blockchain with communication network technology such as IPFS/NDN/CCN.

Each content resource URI defined by ODIN would be parsed and mapped to one or more AP (Access Point) nodes. The AP node is responsible for relaying or providing specific content services according to the PTTP protocol. An AP can be understood as a "router" or "web server" in a peer-to-peer trusted network.

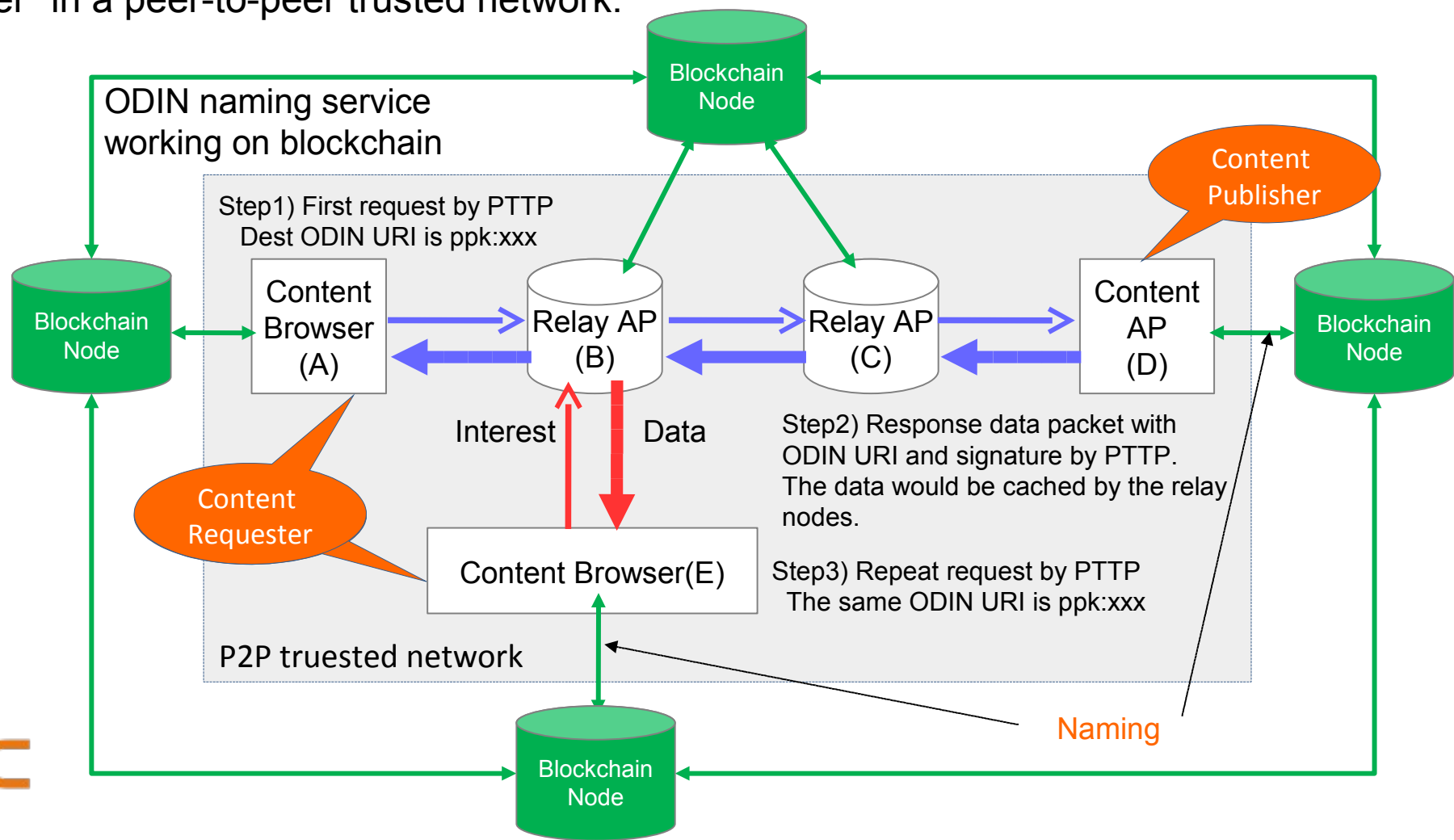

Interest and Data Packets in PTTP

Interest Packet

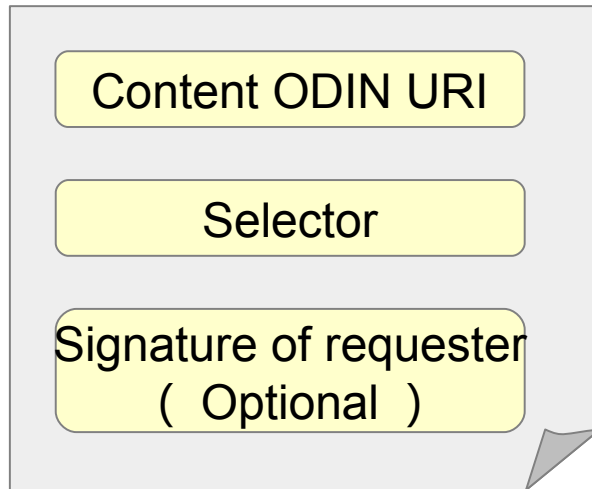

Data Packet

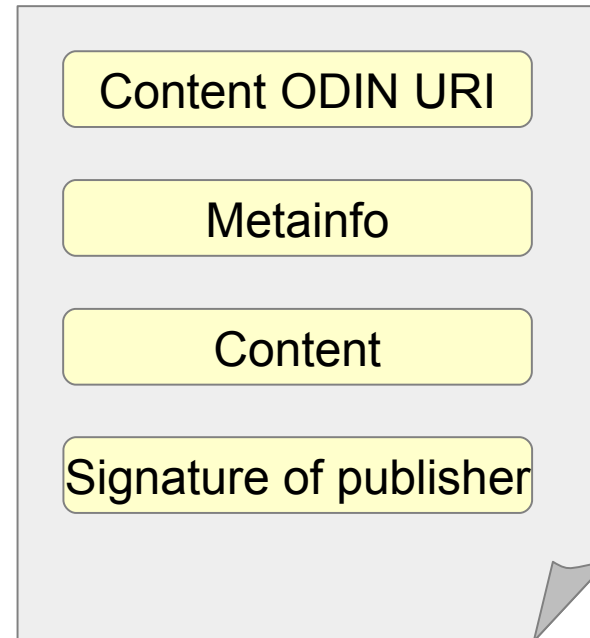

Software structure

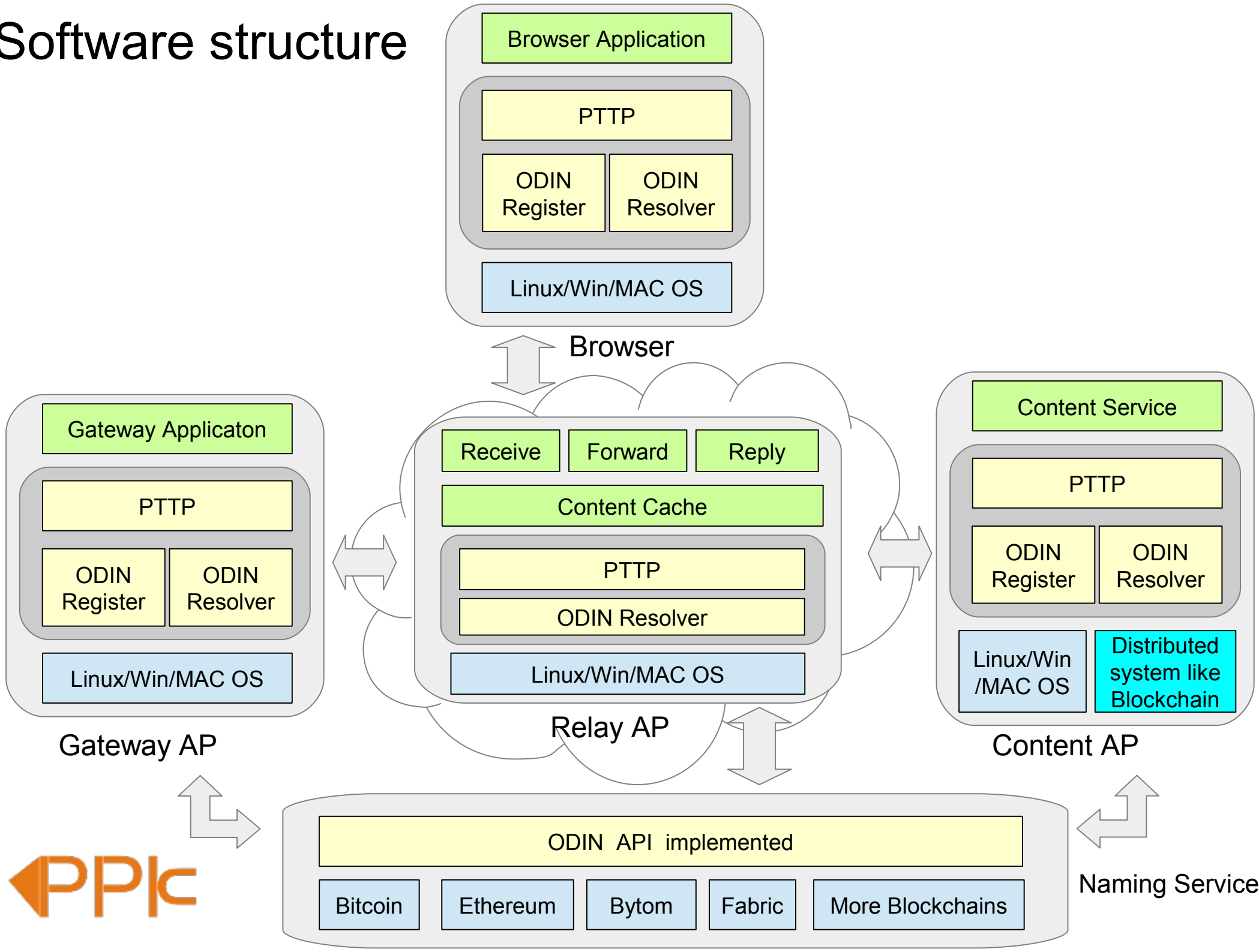

Sample: Blockchain based secure and trusted IoT network

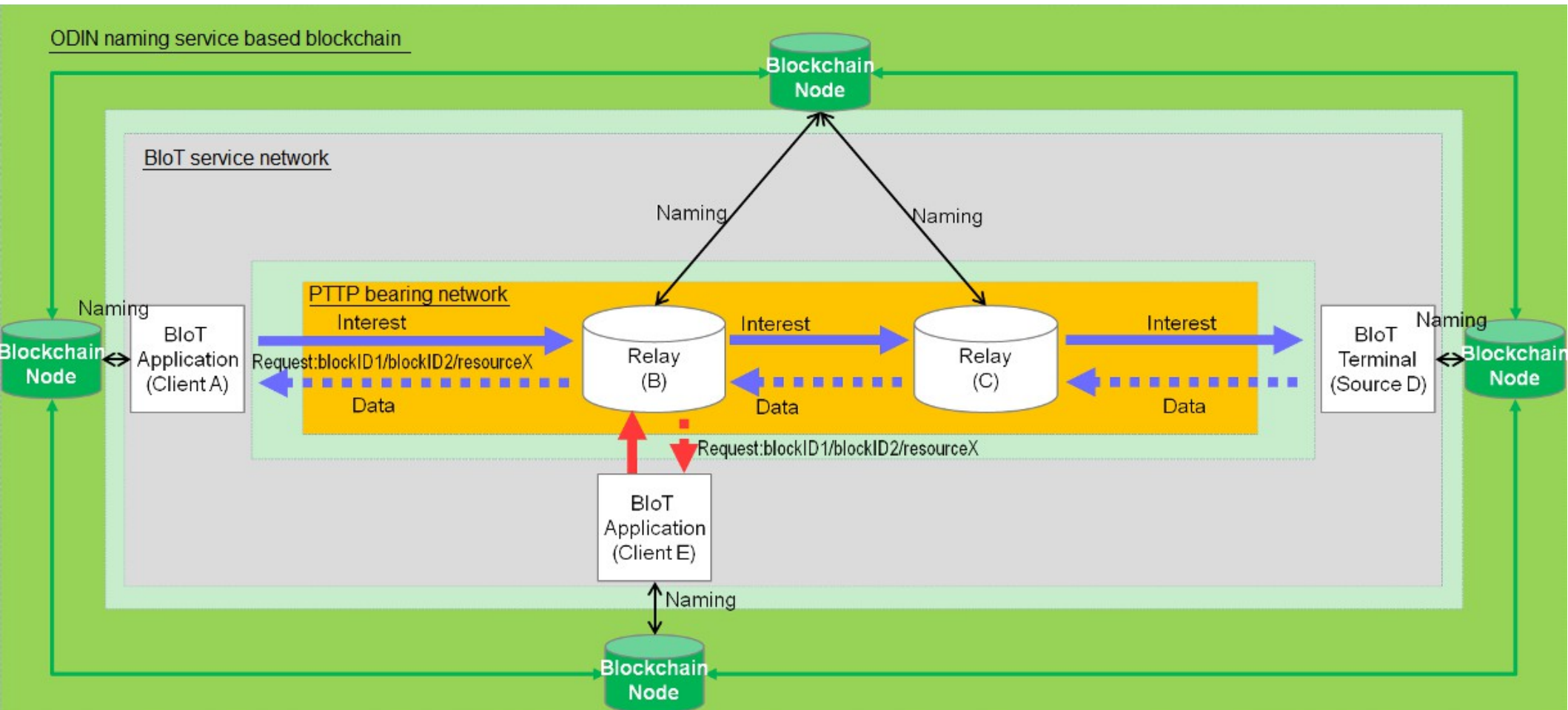

BloT network functional architecture

BloT (Blockchain based secure and trusted IoT) network compose three domains including

(a) ODIN (Open Data Index Name) naming service

Provides secure and trusted Naming service by blockchain nodes.

(b) PTPP (Peer Trusted Transfer Protocol) bearing network

IoT data is transferred by PTPP protocol, which is related to Named Data Network (NDN) and Content-Centric Networking (CCN).

(c) BloT service network.

Applications and Terminal share data effectively, sliced, reliably and transparently.



Summary

Blockchain technology is not only digital cryptocurrency or financial technology, but will be next generation network infrastructure.

Based on blockchain technology, we can define **ODIN(Open Data Index Name)** , an open naming system that is Autonomous, Unique, Secure, and Permanent.

By integrating blockchain with communication network technology such as IPFS/NDN/CCN, we can define **PTTP(Peer Trusted Transfer Protocol)** . Compared with the original DNS+IP system, it could be better adapt and promote the evolution of the Internet, which will lead to a new ecosystem.





Welcome to **PPk** pub.

We love **P2P** network.

drive the future of P !

ppkpub@gmail.com
<http://ppkpub.org>
ppk:/0